

Quick Start Guide

1. Select a location for the ODU

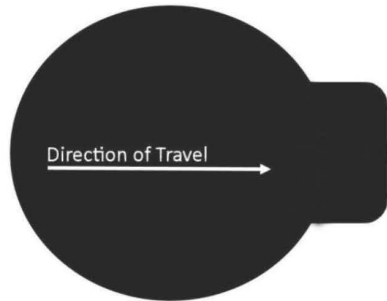

- Pick an area on the roof of your mobile home that will allow the ODU to be mounted as flat and level and strong as possible. With good support that will permit the dish, once fitted and raised, to have a full 360 degree rotation and elevation range.
- Mind the direction of Travel

2. Mount the ODU

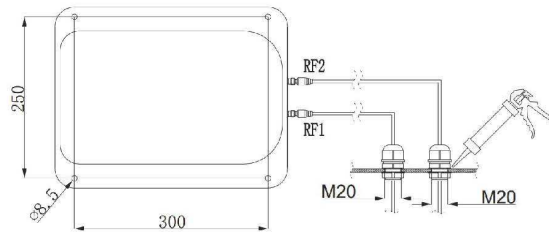

- Drill the mounting holes and cable access hole to prepare the site for installation.
- Ensure that all screw fixings are covered with sealant to ensure that there are no leaks into the RV.

3. Mount the IDU

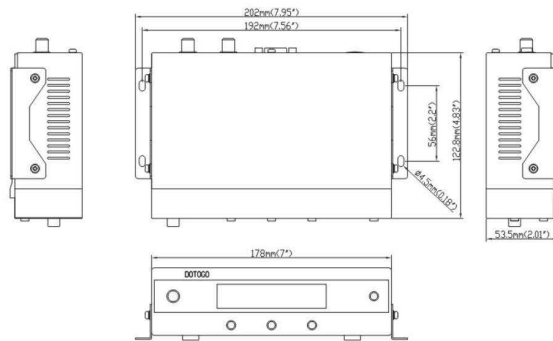

- Dry place is required for IDU to be mounted
- Drill the mounting holes prepare the site for installation.

4. Power cable

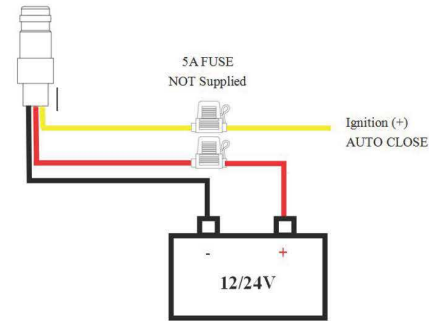

- Red : Positive of battery (VBAT+)
- Black : Cathode of battery (VBAT-)
- Yellow : Ignition (+)

5. Wiring Diagram

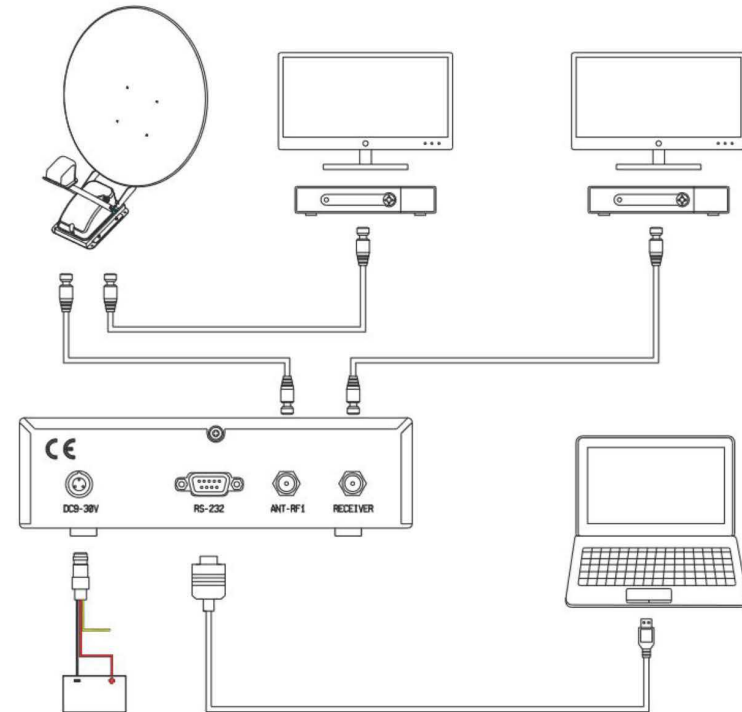

Quick Start Guide

6. Turn on system

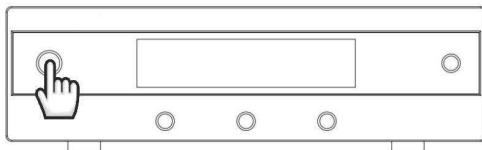

- Turn On Power The antenna system will retract to shut down position and enter into **Sleep Mode**. The power consumption is very low.

7. Deploy system

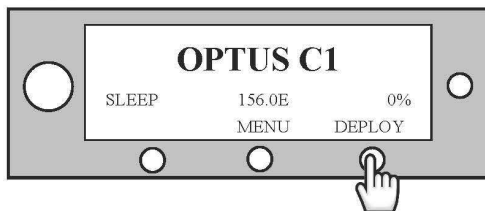

- Press **DEPLOY** will deploy system. Then antenna will lock onto target satellite automatically

8. One-button to change the target satellite

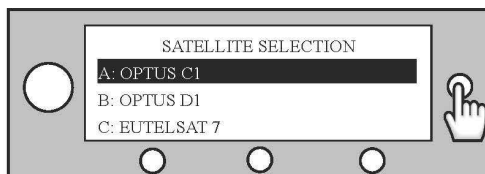

- Press Function key can change You can select the target satellite what you want in the list.
- Wait for 3 second, the target satellite will be selected automatically and tracked by the antenna.
- And it will return to Normal Mode automatically at the same time.

9. Stow system

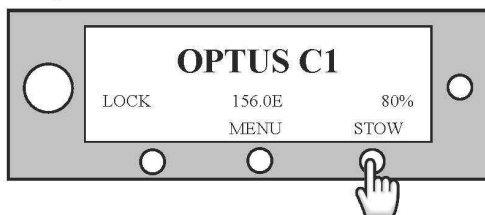

- If you use ignition stow function you install at vehicle, the system will automatically shut down dish on vehicle startup.
- **OR** You can press **STOW**. Antenna system will retract to shut down position
- **Before you driving, please confirm the dish is completely retract to shut down position.**

10. Turn Off System

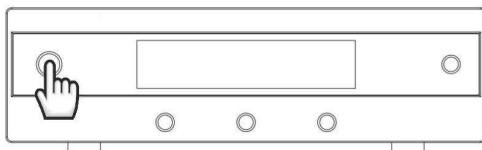

- Press **Power** can turn off the system

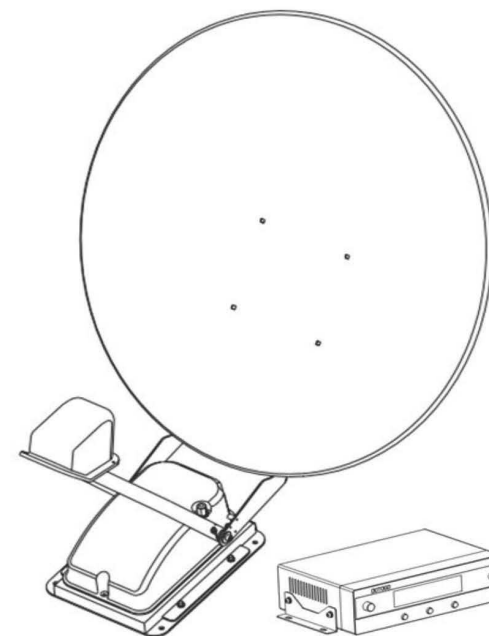

www.OutbackTV.com.au

sales@OutbackTV.com.au

support@OutbackTV.com.au